

Photosensor amplifier



C9329

Digital output function, current-to-voltage conversion amplifier for amplifying very slight photocurrent with low noise

The C9329 is a current-to-voltage conversion amplifier used to amplify very slight photocurrent from a photodiode with very low noise. Three ranges of photocurrent detection sensitivity level (H, M, L) are selectable to match the input signal. The C9329 operates on the built-in dry batteries so it can be easily used anywhere. The C9329 can be directly connected to a personal computer through the RS-232C interface allowing you to acquire high-resolution (16-bit) digital output signals and use the data logger function.

Features

- **Three sensitivity ranges**
H: 1×10^9 (V/A)
M: 1×10^7 (V/A)
L: 1×10^5 (V/A)
- **Selectable operation modes (analog output/digital output)**
- **Serial connection (RS-232C) with PC**
- **Data logger function, low battery function**
- **Operates on either dry battery or AC adapter**

Applications

- **Precision photometry**
- **Laser monitors**
- **Optical power meters**
- **Low signal current preamplifiers**

Absolute maximum ratings (Ta=25 °C unless otherwise noted)

Parameter	Symbol	Value	Unit
Maximum supply voltage	Vcc max	+14	V
Operating temperature*1	Topr	0 to +50	°C
Storage temperature*1	Tstg	-10 to +60	°C

*1: No dew condensation

When there is a temperature difference between a product and the surrounding area in high humidity environment, dew condensation may occur on the product surface. Dew condensation on the product may cause deterioration in characteristics and reliability.

Note: Exceeding the absolute maximum ratings even momentarily may cause a drop in product quality. Always be sure to use the product within the absolute maximum ratings.

Electrical and optical characteristics (Ta=25 °C)

Parameter	Symbol	Condition	Min.	Typ.	Max.	Unit	
Conversion impedance	H	Rf	-	1 × 10 ⁹	-	V/A	
	M		-	1 × 10 ⁷	-		
	L		-	1 × 10 ⁵	-		
Input photo current range	H	Ic	0	-	±5	nA	
	M		0	-	±500		
	L		0	-	±50000		
Frequency bandwidth (-3 dB)	H	fc	DC	16	-	Hz	
	M		DC	1.6 k	-		
	L		DC	1.6 k	-		
Offset drift	-	*2	-	-	±0.5	mV/day	
Temperature drift	-	-	-	-	25	µV/°C	
Analog output (Manual mode)	Maximum output amplitude	VFS	RL=2 kΩ	±5	-	-	V
	Output noise	Vn	Frequency bandwidth*3	-	-	0.5	mVp-p
	Output resistance	Ro		-	100	-	Ω
	Maximum input capacitance	Ct	Overshoot 30% max.	-	-	5000	pF
	Maximum capacitive load	CL		-	-	1000	pF
Digital output (Remote mode)	Interface	-		RS-232C, 19200 bps, 8-bit, non-parity, 2-stop bit			-
	A/D conversion voltage range	-		±5			V
	A/D read cycle	-		-	50	-	ms
Consumption current	Is	*4	-	-	20	mA	
Battery lifetime	-	RL > 10 kΩ*4	-	50	-	hr	

*2: Without photodiode. Maximum output variation measured at 25 °C after 10-minute warm-up after power ON.

*3: Analog output measured after amplified 10 times (through 1.6 kHz low-pass filter)

*4: Without photodiode. When using one alkaline dry battery 6LR61 (006P, 9 V) in analog output.

Typical connection to photodiode

This is an example using a photodiode whose cathode is internally connected to its metal package.

When you use a photodiode metal package, use an insulator to electrically insulate and also hold the package in a shield case as shown in the figure at right. Connect the anode to the shield case.

Any single-element photodiode with a terminal capacitance below 5000 pF can be used.

Using a photodiode with anode grounded is recommended. Using a photodiode with a BNC connector (S2281 series) allows you to easily make measurements because it connects to the C9329 with a BNC-BNC plug coaxial cable.

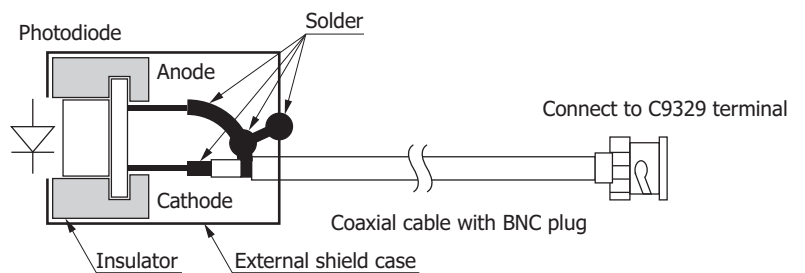

Anode: Connect to the shield wire of the cable and shield case.
Cathode: Connect to the core wire of the cable.

KACCC0221EA

Connection example

Operation example by digital output (Remote mode)

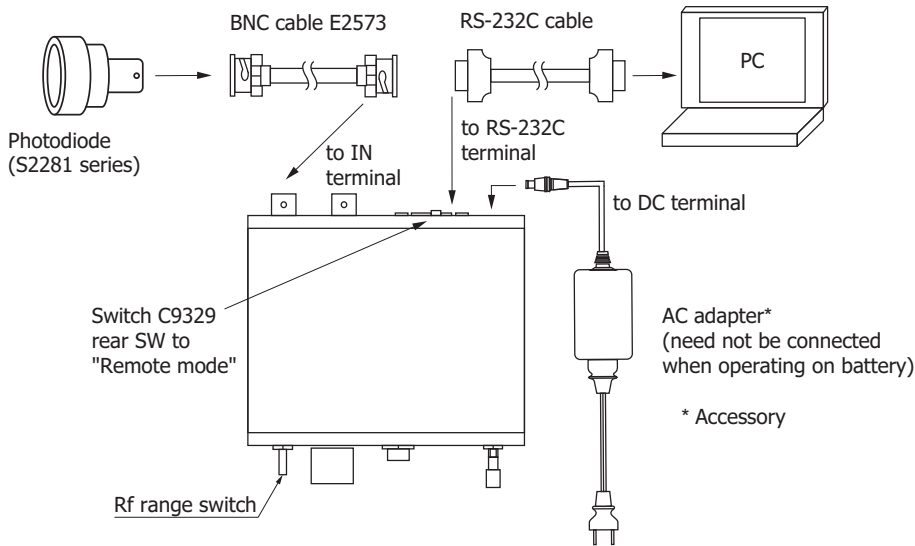

KACCC0222EB

Note: Use the Rf range switch to change the detection sensitivity.
(Detection sensitivity cannot be changed from the PC.)

Display example of accessory sample software

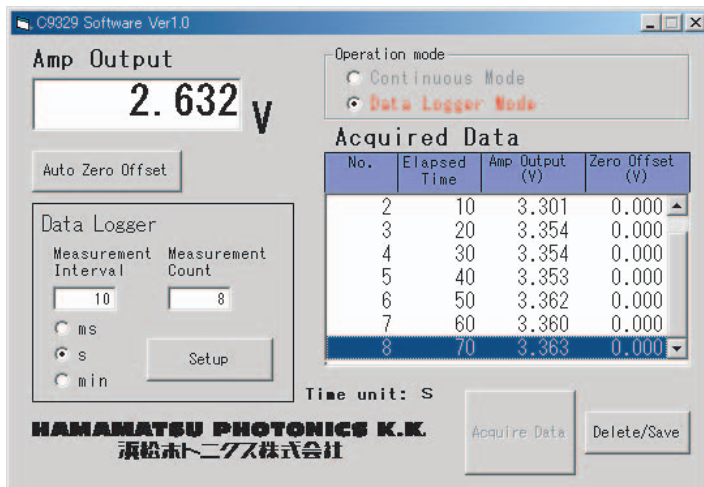

Data logger setting range
 Measurement interval: 50 ms to 1 min
 (50 ms interval)
 Measurement count: 32000 max.
 Measurement interval × Measurement count: 20 hours max.

Microsoft® Windows® 7 Professional SPI (32-bit, 64-bit)

Microsoft Windows 8 Professional (32-bit, 64-bit)

Note: Microsoft and Windows are either registered trademarks or trademarks of Microsoft Corporation in the United States and/or other countries.

Dimensional outline (unit: mm)

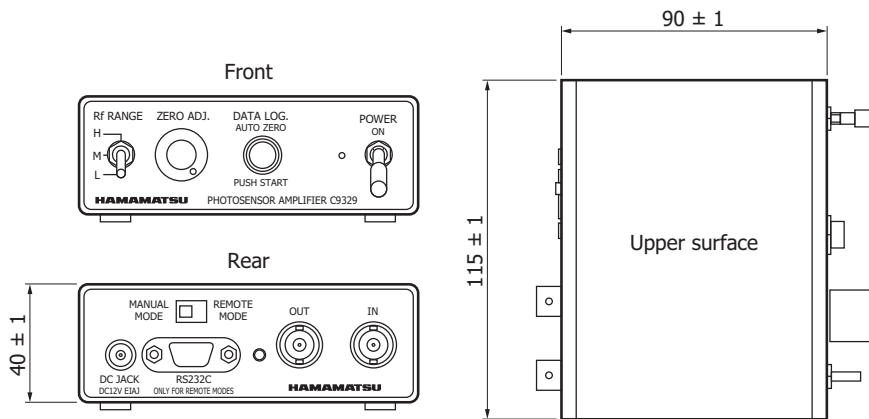

KACCA0137EA

Accessories

- Instruction manual
- Sample software CD-ROM
- AC adapter (plug type: A-2 plug)*5
- Dry battery (built into the unit)

*5: Caution

Depending on the country, an adapter plug might be required when connecting to the AC outlet.

If so, please purchase a proper adapter plug from an electronics supply house.

Photodiode, coaxial cable with BNC-BNC plug and RS-232C cable are not supplied with the C9329. You will need an RS-232C cable (straight cable terminated with a D-sub 9 pin female connector at both ends) available from electronics supply houses.

Options (sold separately, unit: mm)

- BNC cable E2573
- Cable: 1.5D-QEV

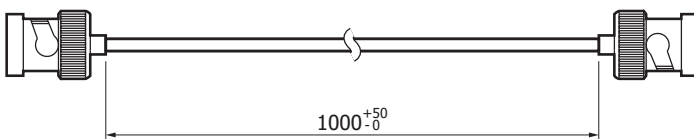

KACCA0334EA

Si photodiodes with BNC connector S2281 series

The S2281 series photodiodes are sealed in a metal package with Photosensitive a BNC connector and designed to connect to The C9329 photosensor amplifier. Two different spectral response ranges are provided. The large photosensitive area makes the S2281 series suitable for optical power meters. A variant type the S9219 with a visual compensation filter is also available. Hamamatsu also provides the E2573 BNC cable (length: 1 m) as an option.



Structure

Parameter	S2281	S2281-01	S2281-04	Unit
Photosensitive area size	φ11.3	φ11.3	φ7.98	mm
Photosensitive area	100	100	50	mm ²
Package	Metal package with BNC connector			-
Window material	Quartz glass			-

Absolute maximum ratings

Parameter	Symbol	S2281	S2281-01	S2281-04	Unit
Reverse voltage	V _R max		5		V
Operating temperature	T _{opr}		-10 to +60		°C
Storage temperature	T _{stg}		-20 to +70		°C

Note: Exceeding the absolute maximum ratings even momentarily may cause a drop in product quality. Always be sure to use the product within the absolute maximum ratings.

Electrical and optical characteristics (T_a=25 °C unless otherwise noted)

Parameter	Symbol	Condition	S2281			S2281-01			S2281-04			Unit
			Min.	Typ.	Max.	Min.	Typ.	Max.	Min.	Typ.	Max.	
Spectral response range	λ		-	190 to 1100	-	-	190 to 1000	-	-	190 to 1100	-	nm
Peak sensitivity wavelength	λ _p		-	960	-	-	720	-	-	960	-	nm
Photosensitivity	S	λ=200 nm	0.10	0.12	-	0.10	0.12	-	0.10	0.12	-	A/W
		λ=λ _p	-	0.5	-	-	0.36	-	-	0.5	-	
Short circuit current	I _{sc}	100 lx	64	80	-	32	40	-	32	40	-	μA
Dark current	I _D	V _R =10 mV	-	50	500	-	6	300	-	50	500	pA
Shunt resistance	R _{sh}	V _R =10 mV	20	200	-	30	1700	-	20	200	-	MΩ
Rise time	t _r	V _R =0 V R _L =1 kΩ	-	3	-	-	7	-	-	3	-	μs
Terminal capacitance	C _t	V _R =0 V f=10 kHz	-	1300	-	-	3200	-	-	1300	-	pF
Noise equivalent power	NEP	V _R =0 V, λ=λ _p	-	1.8×10 ⁻¹⁴	-	-	8.6×10 ⁻¹⁵	-	-	1.8×10 ⁻¹⁴	-	W/Hz ^{1/2}

Spectral response

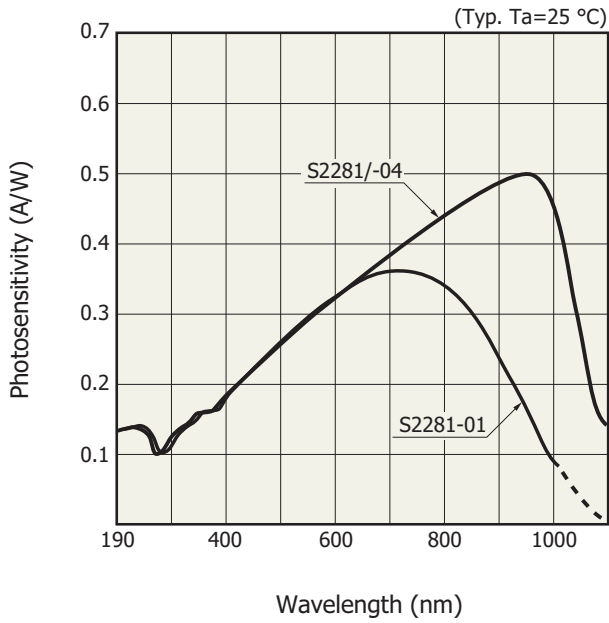

KSPDB0090EA

Dimensional outline (unit: mm)

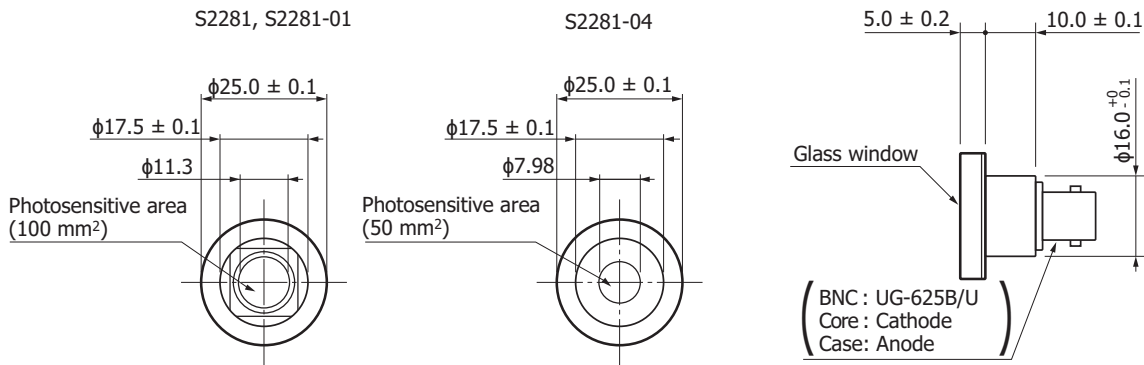

KSPDA0080EA

Related information

www.hamamatsu.com/sp/ssd/doc_en.html

- Precautions
- Disclaimer

Information described in this material is current as of June, 2016.

Product specifications are subject to change without prior notice due to improvements or other reasons. This document has been carefully prepared and the information contained is believed to be accurate. In rare cases, however, there may be inaccuracies such as text errors. Before using these products, always contact us for the delivery specification sheet to check the latest specifications.

The product warranty is valid for one year after delivery and is limited to product repair or replacement for defects discovered and reported to us within that one year period. However, even if within the warranty period we accept absolutely no liability for any loss caused by natural disasters or improper product use. Copying or reprinting the contents described in this material in whole or in part is prohibited without our prior permission.

HAMAMATSU

www.hamamatsu.com

HAMAMATSU PHOTONICS K.K., Solid State Division

1126-1 Ichino-cho, Higashi-ku, Hamamatsu City, 435-8558 Japan, Telephone: (81) 53-434-3311, Fax: (81) 53-434-5184

U.S.A.: Hamamatsu Corporation: 360 Foothill Road, Bridgewater, N.J. 08807, U.S.A., Telephone: (1) 908-231-0960, Fax: (1) 908-231-1218

Germany: Hamamatsu Photonics Deutschland GmbH: Arzbergerstr. 10, D-82211 Herrsching am Ammersee, Germany, Telephone: (49) 8152-375-0, Fax: (49) 8152-265-8

France: Hamamatsu Photonics France S.A.R.L.: 19, Rue du Saule Trapu, Parc du Moulin de Massy, 91882 Massy Cedex, France, Telephone: 33-(1) 69 53 71 00, Fax: 33-(1) 69 53 71 10

United Kingdom: Hamamatsu Photonics UK Limited: 2 Howard Court, 10 Tewin Road, Welwyn Garden City, Hertfordshire AL7 1BW, United Kingdom, Telephone: (44) 1707-294888, Fax: (44) 1707-325777

North Europe: Hamamatsu Photonics Norden AB: Torshamnsgatan 35 16440 Kista, Sweden, Telephone: (46) 8-509-031-00, Fax: (46) 8-509-031-01

Italy: Hamamatsu Photonics Italia S.r.l.: Strada della Moia, 1 int. 6, 20020 Arese (Milano), Italy, Telephone: (39) 02-93581733, Fax: (39) 02-93581741

China: Hamamatsu Photonics (China) Co., Ltd.: B1201, Jiaming Center, No.27 Dongsanhuan Beilu, Chaoyang District, Beijing 100020, China, Telephone: (86) 10-6586-6006, Fax: (86) 10-6586-2866